

**SYLEX**  
**ERGONOMICS**  
www.sylex.com



designed for the way we work today

technology furniture  
05/06



The pace of life today is accelerating rapidly and to live and work efficiently we need space and surroundings that work the way we do. Clean uncluttered space. Yet most of the furniture for computers that you see seems more like kitchen cabinets than furniture for our living and working areas.

This latest range of Technology Furniture from Sylex Ergonomics is based upon some simple guiding principles:

- Flexibility
- Adaptability
- Easy access

**Flexibility:** Not everyone wants to work facing a wall, but many competitors' products are unfinished on the back, leaving raw unsightly panels exposed and forcing you to locate your computer against a wall. That means that you cannot see what is going on around you and invites "rubbernecks" to see what you are working on.

**Adaptability:** Simple clean and modular pieces of furniture can be easily relocated and reconfigured in the office space. Storage units are separate so they can be located exactly where you need them. Mobile units move easily to allow you to change your working environment quickly and easily. Folding units swing out to create additional workspace or fold away for convenience.

**Easy access:** Today we want to be able to quickly access our hardware with plenty of desktop space for the larger Multifunction Centres and other peripherals.

*\*All products delivered cartonised and ready to assemble. Assembly and delivery service available upon quotation.*

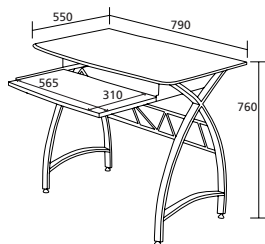

### FPWGM07017

compact glass workstation with slide out keyboard tray

## compact work

compact glass workstation with monitor platform and slide out keyboard tray

### FPWGM07073

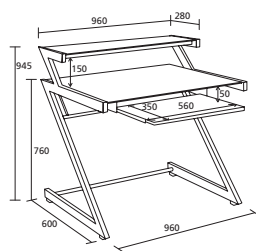

**SYLEX**  
ERGONOMICS  
www.sylex.com



**FPWGM07032**

compact mobile workstation with slide out keyboard tray and underdesk shelf

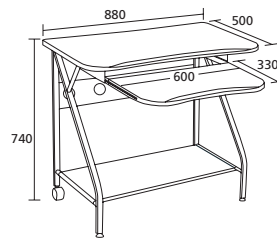

s t a t i o n s

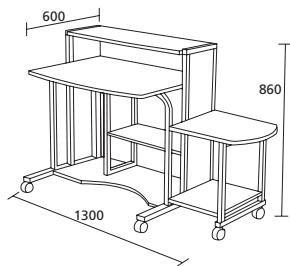

compact mobile workstation with multiple storage shelves and attached printer stand

**FPWGM07038**



**FPWGM07069**

compact cherry finish workstation with monitor platform and slide out keyboard tray

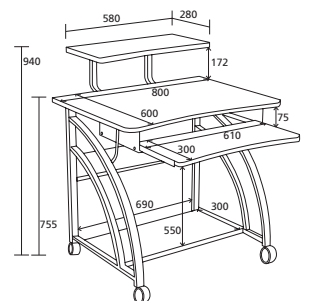



Stylish, contemporary and very desirable these full sized glass workstations set new standards in elegance. Glass is very much in vogue now because it complements any modern space. As well as looking smart these units work smart as well.

All glass workstations feature toughened (tempered) glass desktops in compliance to British Standards for glass top thicknesses based on the size of the desktop and the location of supports.

FPWGM07095



# full size glass wor

FPWGM07094

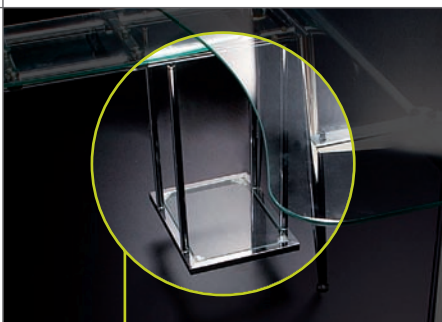

Glass swingaway workstation with chromed frame and CPU holder. This is the ideal unit for areas requiring flexibility. Can be used folded up in a compact format, set at 90 degrees or extended all the way out. Comes complete with undercarriage CPU holder.

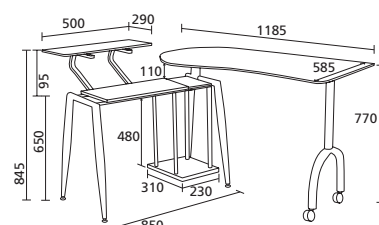



Stylish leg shape, robust construction and loads of working area make this the desk the choice of the discerning professional

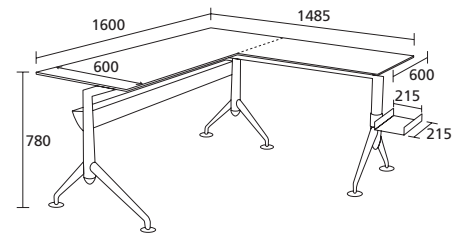

# k s t a t i o n s

## FPWGM07033

3 piece corner workstation now available in elegant white frosted glass tops and silver powder coated frame. Comes complete with monitor/printer stand and slide out keyboard tray

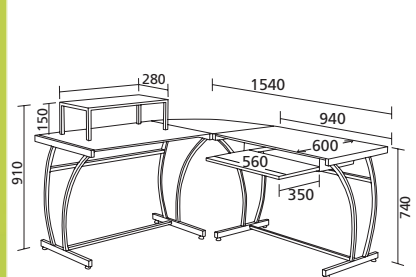
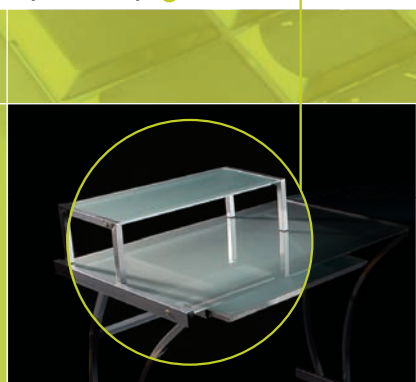

# full sized timber workstations

Fully finished front and back these units are at home either against the wall or facing your visitors. Featuring hard wearing powder coated steel frames these desks will enhance your image without breaking the budget.

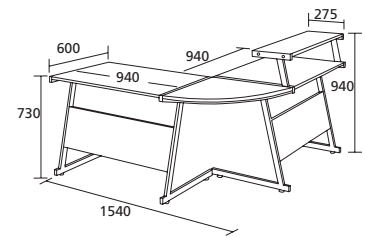

## FPWGM07007

Economical and functional 3-piece corner unit. Comes complete with monitor/printer platform. Ideal desk for both computing and paper based tasks.

## FPWGM07040

Clever swingaway unit with separate printer platform, features sturdy powder coated frame and soft curved edge tops.

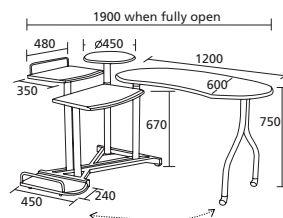

\* Keyboard dimension 400 x 600





FPWGM07090

This professional desk comes complete with tool bar/letter tray, slide out keyboard tray and CPU holder with soft curved edge tops. Extension piece may be set left or right.

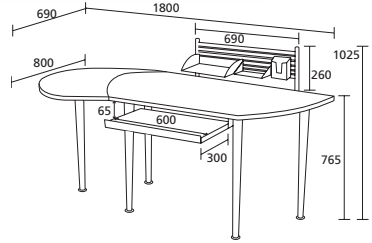

compact, height adjustable stands

FTSGM07106



Lectern With 2 shelves and a height and tilt adjustable top. Powder coated steel fascia. Beech finish top and shelves.

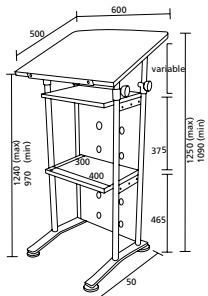

FPOGM07082W

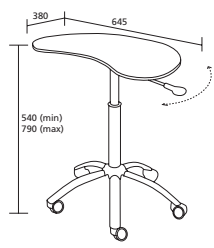

Compact mobile laptop platform. Adjustable height. Position your laptop just where you want it. Gas-lift adjustable between 540 and 790.

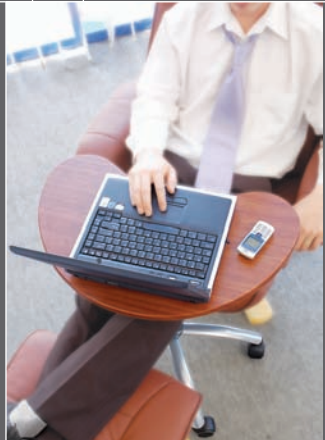

# bookcases & storage

FFSGM06032  
FFSGM06034

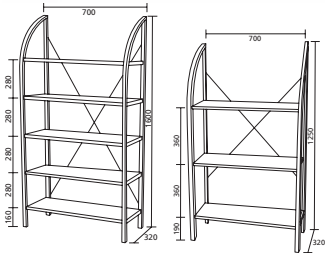

Tempered glass shelving units with cross brace for excellent rigidity. Powder coated steel frame.

AWDGM09001

6 piece desk set powder coated silver, Contains letter tray, paper clip cup, pencil cup, mail sorter, drawer pencil tray and ruler

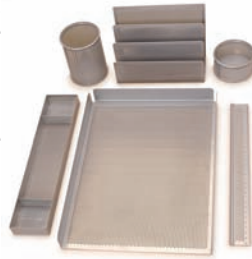

AWOGM09002

250mm diameter mesh waste bin



FFBGM09012

4 shelf bookcase with sliding cover



FFMGM09011

3 shelf CD storage cupboard with sliding cover



FFFGM07087



Mobile File Cart holds foolscap hanging files

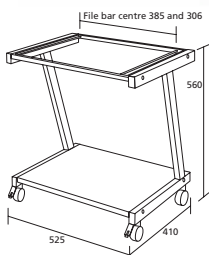

Official Sylex Dealer

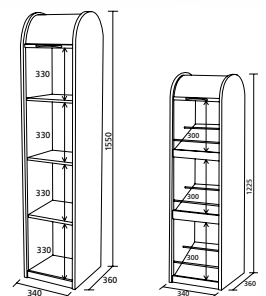

## Australia

**Sydney** - Head Office  
4-6 Bentley Street  
Wetherill Park 2164  
Ph: 61 2 9756 4988  
Fax: 61 2 9756 4991

**Melbourne**  
403 Flemington Road  
North Melbourne 3051  
Ph: 61 3 9329 2900  
Fax: 61 3 9329 2836

**Perth**  
224 Planet Street  
Welshpool 6106  
Ph: 61 8 9472 5200  
Fax: 61 8 9472 5211

**Queensland**  
4/272 Lavarack Avenue  
Eagle Farm 4009  
Ph: 61 7 3260 2060  
Fax: 61 7 3260 2070

## New Zealand

**Auckland**  
55A Druce's Road  
Manukau City  
Ph: 64 9 2621429  
Fax: 64 9 2621434

Copyright 2004 by SYLEX DISTRIBUTORS PTY LTD A.B.N. 72 002 361 195

Products in this catalogue include items protected by patents, patents pending, registered designs and trademarks held within the SYLEX group of companies.  
Acoustics and Felts Pty Ltd A.B.N. 29 001 636 004. Sylex Distributors Pty Ltd A.B.N. 72 002 361 195, Sylex Sales Pty Ltd A.B.N. 39 005 473 030,  
Sylex Pty Ltd A.B.N. 44 010 092 903.

Due to continual product improvement we reserve the right to alter specifications of product from time to time without notice.

www.sylex.com